

DURITE®

7" COLOUR AHD CCTV Kit with 3 Channel Input

12-24VDC

Part 0-776-72

WARNINGS

Before using this unit please read these instructions carefully. Take special care to follow the warnings indicated on the unit itself as well as the safety suggestions listed below. Keep these instructions for future reference

 **HIGH VOLTAGES WITHIN THIS EQUIPMENT. RISK OF ELECTRIC SHOCK, DO NOT RE-MOVE COVER**



 **WARNING:** The vehicle safety vision system is designed to be used with, not instead of other viewing aids in your vehicle. The manufacturer shall not be held liable for any accidents which occur while operating this system.

- Please ensure you are familiar and comply with local traffic and driving regulations.
- Power Source - The monitor should be connected to a 12 - 24 volt dc power supply only.
- Water and Moisture - Do not use the monitor where it may be subject to water ingress or excessive moisture. Do not use outside the vehicle unprotected.
- Heat - Do not install the monitor or camera near a direct heat sources.
- Ventilation - The monitor should be situated to allow free circulation of air.
- Foreign Material - Care should be taken so that objects do not fall onto or into, and that liquids are not spilled on the monitor.
- Mounting Surface - The monitor should be mounted to a strong secure surface.
- Replacement Parts - Use only manufacturers replacement specified parts. Unauthorised substitutions may result in fire risk, electric shock or other hazards and will void the warranty
- Service - The user should not attempt to service this units beyond that described in the operating instructions. There are no user-serviceable parts within the unit.
- Isolation - When fitting to an isolated earth vehicle the camera and monitor bracket must also be electrically isolated from the vehicle chassis. If interference is experienced on earthed chassis vehicles electrically isolating the camera from the chassis should eliminate the interference.
- Screen Protective Film - Remove the LCD screen protective plastic cover before use.

MONITOR INSTRUCTION

Remote Control Instruction :

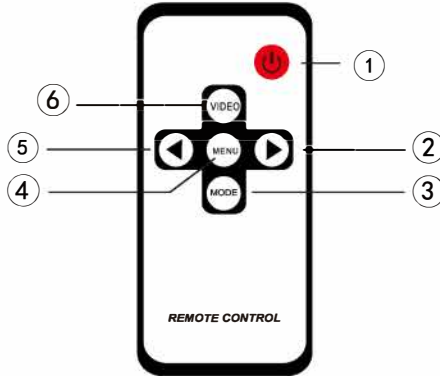

REMOTE INSTRUCTION

- ① Power on
- ② Up selection
- ③ Mode selection
- ④ Menu
- ⑤ Down selection
- ⑥ Video selection

MENU OPERATION

Press 'MENU' button, the screen will show "Display"/"Language"/"Function"/"System" setting menu, press "+" / "-" button to select up and down .

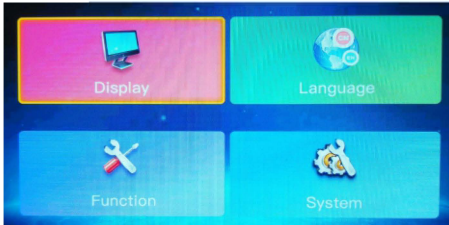

Main menu : Display / Language / Function / System setting

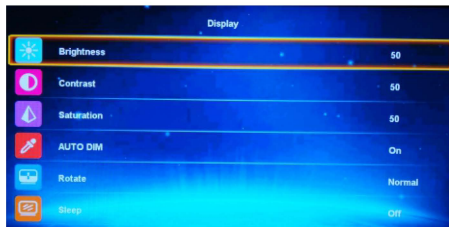

Display: Brightness / Contrast / Saturation / Auto Dim / Rotate / Sleep

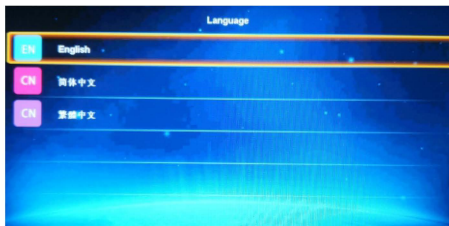

Language : default is English in the menu

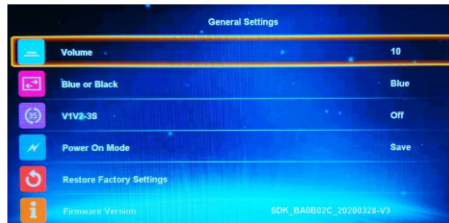

Function: Volume / Blue or Black background / Restore factory setting



NOTE after finishing the setting , please wait until the setting menu disappeared , then press power button to close the system and power again, the new setting will be saved in the system .
Directly turning off the vehicle ACC will not save the new setting .

MENU OPERATION

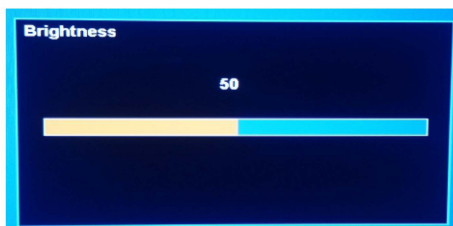

Brightness: press “+”/”-” button to select up and down parameter setting

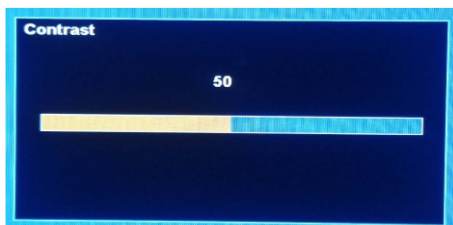

Contrast: press “+”/”-” button to select up and down parameter setting

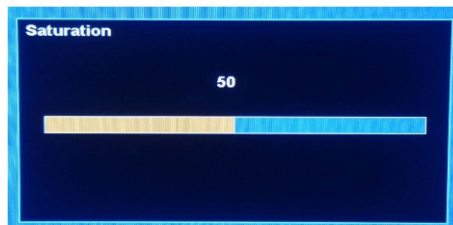

Saturation: press “+”/”-” button to select up and down parameter setting



Reverse :
Reversing guide- on/off to select the parking guide line , default off

Reversing priority-default off

Reversing delay -default 2 second , select the option for setting

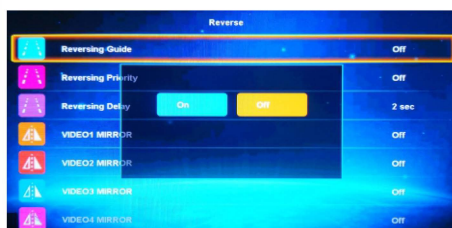

Video1/video2/video3 mirror image -default off, select the option for setting. Video 4 Not Used.

WIRING DIAGRAM

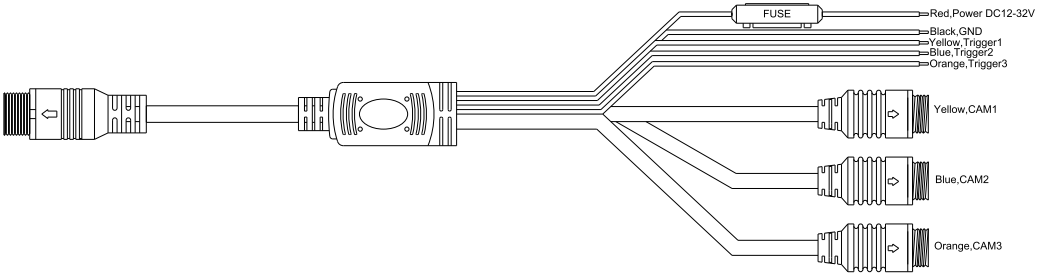

960P AHD CAMERA



CAMERA DIMENSIONAL DRAWING

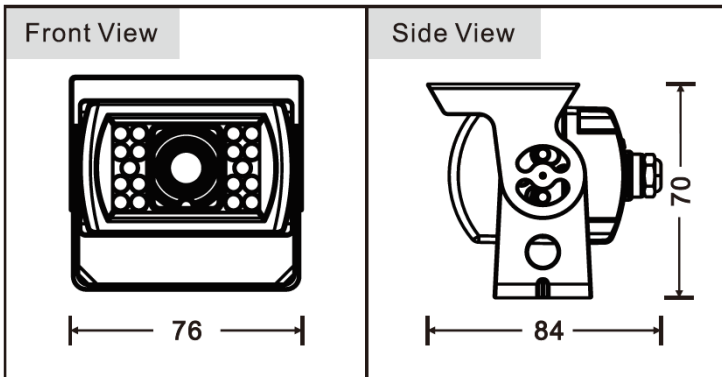

SPECIFICATION

Product Type.....3 Channel CCTV AHD Monitor
 Voltage.....12/24VDC
 Size.....7 Inch
 Resolution.....1024 x RGB x 600
 TV System.....PAL or NTSC for option
 Power.....5W
 Contrast.....500:1
 Response Time.....20ms
 Connector type.....4 PIN aviation
 Reverse Polarity.....Yes
 Audio.....Yes
 Operating Temp.....-20°C~60°C,RH90% MAX
 Storage Temp.....-30°C~70°C,RH90% MAX
 Weight.....0.44KG
 Dimensions.....177(L)*122(W)*26MM(H)
 Certi cates.....E Marked ECE R10

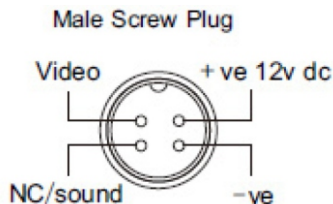

Type.....1/3" (6 mm) Colorful CMOS Aptina AR0130
 Voltage.....12VDC
 Resolution.....Analog HD 1280 (H) x 960 (V)
 Sensitivity.....0.1LUX
 S/N Ratio.....48dB
 Current Draw.....250mA
 Electronic Shutter.....Auto
 Lens.....f 2.8mm
 View Angle.....(H)120° (V) 90°
 Video Output.....1 Vpp, 75 Ohm
 IP Rating.....IP68
 Auto Gain Control.....Yes
 Microphone.....Yes
 Weight.....360g
 Dimensions.....L 84 x W 76 x H 70mm
 Operating Temperature.....-20 C to 70 C RH95% MAX
 Storage Temp.....-30°C to 85°C, RH95% MAX
 Certi cates.....E Marked

